

Three-phase multifunction energy meter **3F-7DIN 7321 WIFI Series**

User Guide V1.0



Safety Information

Important Information

Read these instructions carefully and look at the equipment to become familiar with the device before trying to install, operate, service or maintain it. The following special messages may appear throughout this bulletin or on the equipment to warn of potential hazards or to call attention to information that clarifies or simplifies a procedure.



The addition of either symbol to a “Danger” or “Warning” safety label indicates that an electrical hazard exists which will result in personal injury if the instructions are not followed.



This is the safety alert symbol. It is used to alert you to potential personal injury hazards. Obey all safety messages that follow this symbol to avoid possible injury or death.

DANGER

DANGER indicates an imminently hazardous situation which, if not avoided, will result in death or serious injury.

WARNING

WARNING indicates a potentially hazardous situation which, if not avoided, can result in death or serious injury.

CAUTION

CAUTION indicates a potentially hazardous situation which, if not avoided, can result in minor or moderate injury.

NOTICE

NOTICE is used to address practices not related to physical injury. The safety alert symbol shall not be used with this signal word.

Please Note

Electrical equipment should be installed, operated, serviced, and maintained only by qualified personnel. No responsibility is assumed by Nova for any consequences arising out of the use of this material.

A qualified person is one who has skills and knowledge related to the construction, installation, and operation of electrical equipment and has received safety training to recognize and avoid the hazards involved.

Table of Contents

Chapter 1. Overview	- 1 -
1.1. Introduction.....	- 1 -
1.2. Characteristics	- 1 -
1.3. Parameters.....	- 1 -
Chapter 2. Technical parameters specification	- 2 -
2.1. Specification.....	- 2 -
2.2. Installation dimensions.....	- 4 -
2.3. Wiring Diagrams.....	- 4 -
Chapter 3. General function description	- 5 -
3.1. Multi-tariffs function.....	- 5 -
3.2. Demand calculation method.....	- 6 -
3.3. Definition of monthly freeze and daily freeze.....	- 6 -
3.3.1. Monthly freeze rules	- 6 -
3.3.2. Daily freeze rules	- 7 -
3.3.3. How to setting the month freeze date and day freeze time.....	- 7 -
Chapter 4. Operation	- 8 -
4.1. Meter startup instructions	- 8 -
4.2. LCD display area description	- 8 -
4.3. Network config operation	- 9 -
4.4. Button definition description	- 10 -
4.5. Description of display screen	- 10 -
4.5.1. Main display screen.....	- 10 -
4.5.2. Auxiliary display screen	- 13 -
4.6. Setting-up	- 14 -
4.6.1. Set communication class parameters.....	- 15 -
4.6.2. Set system class parameters.....	- 16 -
4.6.3. Set pulse output class parameters.....	- 17 -
4.6.4. Set demand class parameters	- 19 -
4.6.5. Set time class parameters.....	- 20 -
4.6.6. View alarm parameters	- 22 -
Chapter 5. Alarm	- 24 -

5.1. Alarm parameter description	- 24 -
5.2. Alarm parameter setting process.....	- 25 -
5.3. Alarm action process	- 25 -
Appendix	- 26 -
Appendix A – LCD character definition table	- 26 -
Appendix B – Failure code reference table	- 26 -
Appendix C – Alarm prompt comparison table	- 26 -
Appendix D – WIFI indicator status table.....	- 26 -

Chapter 1. Overview

1.1. Introduction

3F-7DIN 7321 WIFI series products are the three phase multi-function meter for collection, analysis and remote control of electric parameters. This series products can support wireless communication way like WIFI. Carrying Tuya platform can realize the remote access of mobile APP terminal and operation for relay. This series products can provide a variety of analytical parameters, such as voltage, current, power, power factor ect. Meanwhile it also can provide variety of electric energy parameter measurement, such as two-way active energy, reactive energy, monthly and daily electricity consumption statistics. This series products can support in the 3P4W grid environment analysis of electric power parameter measurement, as well as the inbuilt-relay can support remote control, prepay management control and other functions, suitable for school management, shopping mall charge management, real time power monitoring system and many other application environment, have the multi-function, many applications, high stability and long life characteristics. This series products have RS485 communication interface, baud rate up to 9600bps, support Modbus protocol, which can easily realize the function of remote data read, and adopt the design of large-screen LCD and press button, which can easily carry out the local view and set operation of various parameters. The product has the function of password protection, which ensures the data security of the product.

1.2. Characteristics

- Maximum current 80A direct access
- By carrying Tuya platform, the meter can connect the internet automatically and remote data collection, control relay.
- Multi-function parameter measurement, providing voltage, current, active power, reactive power, apparent power, power factor, phase Angle, etc
- Providing a variety of statistical data and local storage functions, such as two-way energy, demand and other statistical data. Provide monthly electricity consumption statistics for the last 12 months and daily electricity consumption statistics for the last 31 days.
- Support electricity parameter monitoring alarm function.
- In-built relay, support relay remote control and prepay management control.
- Support one pulse optocoupler outlet interface, can set pulse output parameter.
- Support RS485 communication function, baud rate up to 9600bps, support Modbus RTU.
- Support WIFI wireless communication.
- DIN rail mounting
- Big LCD screen with backlit, backlight lighting time adjustable.
- LCD refresh time is 1 second, support manual or automatic scroll display (configurable).

1.3. Parameters

1. The Unit can measure and display	
Instantaneous RMS Values	
Current	Per phase, neutral
Voltage	L-N

Frequency	45 to 65Hz
Active power	Total and per phase
Power factor	Total and per phase
Energy Value	
Total active energy	0 to 999999.999 kWh
2. The Unit can measure and communication read	
Instantaneous RMS Values	
Power	Reactive power, Apparent power (include:Total and per phase)
Maximum Demand Values	
Max.Demand of current	Per phase
Max.Demand of power	Total active power, Total reactive power, Total apparent power
Energy Values (include: import, export, import + export)	
Active energy	0 to 999999.999 kWh
Reactive energy	0 to 999999.999 kvarh
Multi-Tariff active energy (T1 - T4)	0 to 999999.999 kWh, include: import, export, import+export
Multi-Tariff reactive energy (T1 - T4)	0 to 999999.999 kvarh, include: import, export, import+export
Monthly electricity consumption for the last 12 months	Total active energy Range: 0 to 999999.999 kWh
Daily energy consumption for the last 31 days	Total active energy Range: 0 to 999999.999 kWh
3. The Unit can settable	
Communication class	Modbus address, baud rate, parity bit, stop bit
System configuration class	User password (HMI), Reset Max.Demand
Demand class	Demand interval period, Slide time
Pulse output class	Pulse output type, Pulse output width, Pulse output rate
Time class	Automatic scroll display time, Backlit time, System time (RTC), Tariff time
Alarm class	Alarm object, alarm action delay time, alarm threshold value, alarm status view

Chapter 2. Technical parameters specification

2.1. Specification

Electrical Characteristics		
Type of measurement		RMS including harmonics on AC system, support 3P4W, 1P2W
Measurement accuracy	Voltage, Current	Class 0.2, according IEC 61557-12
	Active power	Class 1 / 0.5, according IEC 61557-12
	Reactive power	Class 2, according IEC 61557-12
	Apparent power	Class 1, according IEC 61557-12
	Active energy	Class 1 / 0.5S, according IEC 62053-22, IEC 61557-12
	Reactive energy	Class 2, according IEC 62053-23, IEC 61557-12
	Power factor	Class 1, according IEC 61557-12
	Frequency	Class 0.2, according IEC 61557-12
Data update rate		1 second

Input-Voltage	Rate voltage (Un)	230 Vac (L-N) / 400 Vac (L-L)
	Direct connection	Measured range : 85 to 270 Vac (L-N), 85 ~ 480 Vac (L-L)
	Frequency range	45 to 65 Hz
	Overload capacity	2*Un for 1 second
Input-Current	Measured range	0.005 to 80 A, basic current (Ib) is 5A
	Overload capacity	30*I _{max} for 0.01 second
Pulse output	Interface type	Open collector optocoupler
	Pulse constant	1000 / 100 / 10 / 1 imp/kWh(kvarh) (Configurable)
	Pulse width	60/100/200 milliseconds (Configurable), default is 100milliseconds
	Pulse output type	Import/export/total active energy, Import/export/total reactive energy (Configurable)
	Class	Class A, according IEC 62053-31
	Input voltage	5 ~ 27 Vdc
Pulse indicator light on the panel		Pulse constant is 1000imp/kWh
Real-time clock accuracy		0.5 s/d
Mechanical Characteristics		
IP Degree of Protection (IEC 60529)		Designed to IP51 front display, IP30 meter body
Dimensions (W X H X D)		126 x 98 x 80 mm
Mounting Position		DIN Rail mounting
Material of meter case		UL 94 V-0
Environmental Characteristics		
Operating Temperature		-25 to +55°C
Storage Temperature		-40 to +80°C
Humidity		< 90%, non-condensing
Pollution Degree		2
Altitude		Up to 2000m
Vibration		10 Hz to 150Hz, IEC 60068-2-6
Electromagnetic Characteristics		
Electrostatic Discharge		Level 4, according IEC 61000-4-2 ⁽¹⁾
Immunity to Radiated Fields		Level 3, according IEC 61000-4-3 ⁽¹⁾
Immunity to Electrical Fast Transients		Level 4, according IEC 61000-4-4 ⁽¹⁾
Immunity to Surges		Level 4, according IEC 61000-4-5 ⁽¹⁾
Immunity to Conducted Disturbances		Level 3, according IEC 61000-4-6 ⁽¹⁾
Immunity to Magnetic Fields		IEC 61000-4-8 ⁽¹⁾
Immunity to Voltage Dips		IEC 61000-4-11 ⁽¹⁾
Radiated Emissions		Class B, according EN55011
Conducted Emissions		Class B, according EN55011
Harmonics		IEC 61000-3-2 ⁽¹⁾
(1): The experimental test is carried out according to the grade requirements of industrial grade products in IEC61326-1		
Safety		
Measurement Category		CAT III, according IEC 61010-1
Overvoltage Category		CAT III, according IEC 61010-1
Insulation		AC Voltage Test: 4kV for 1 minute

	Impulse Voltage Test: 6kV - 1.2/50 μ S waveform
Protective Class	II, according IEC61010-1
Bus Communications	
Interfaces standard and protocols	2-wire RS485, Modbus RTU Optional: MBus
Buad rate	1200 to 9600 bps, default is 9600 bps
Parity bit	None, Even, Odd, default is None
Stop bit	1 or 2, default is 1
Response time	<100ms
Transmission mode	half-duplex
Transmission distance	Up to 1000m
Max. Bus loading	32 pcs
Wireless communication	
Supported wireless types	WIFI

2.2. Installation dimensions

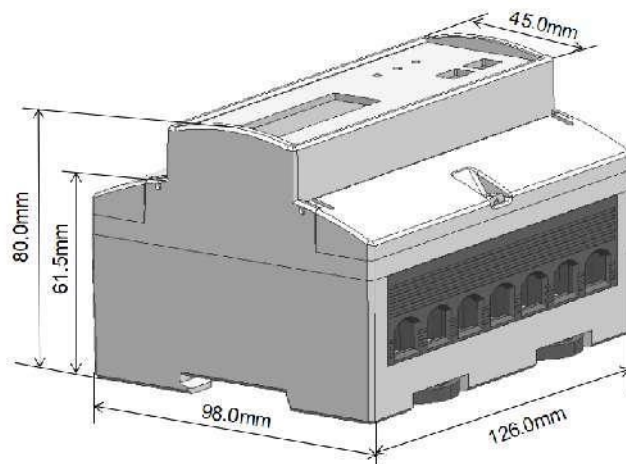

2.3. Wiring Diagrams

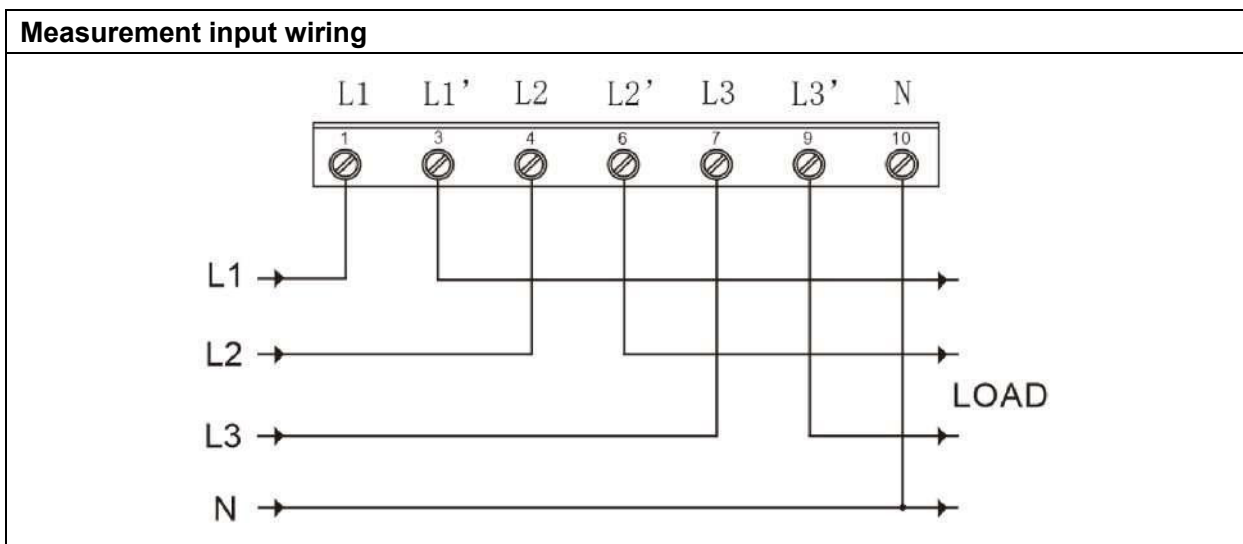

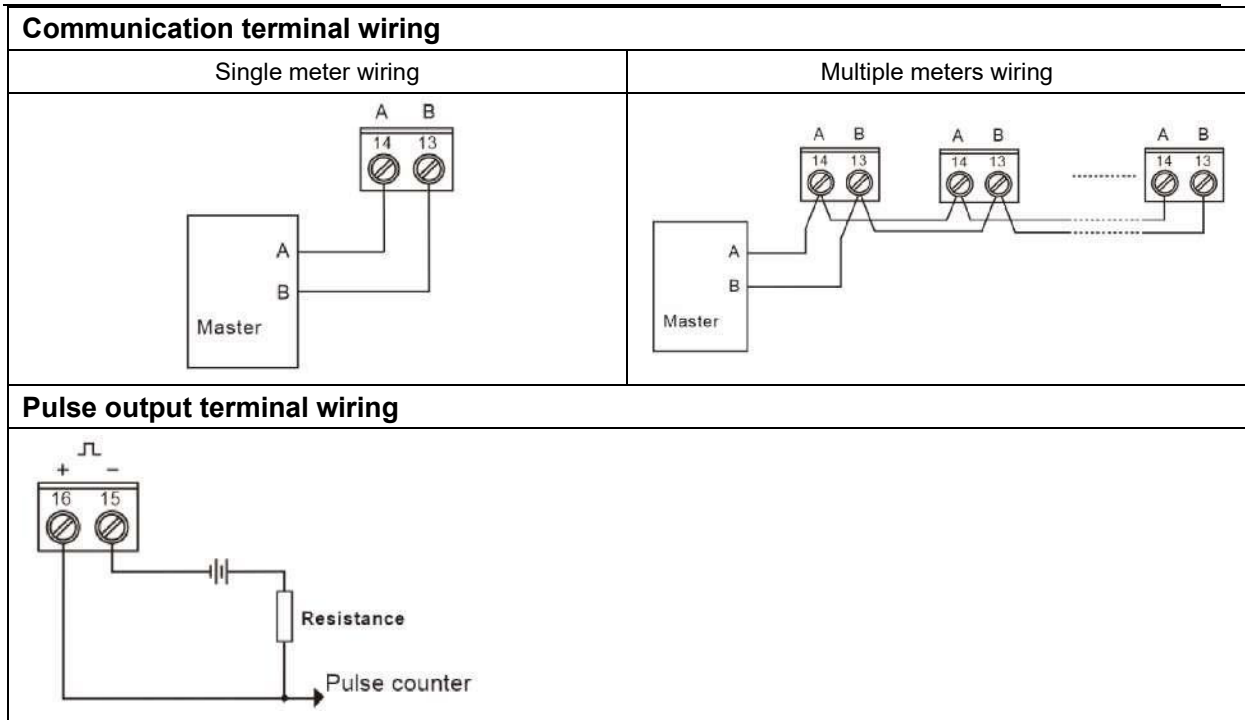

Chapter 3. General function description

3.1. Multi-tariffs function

The multi-tariffs function refers to the function that the meter realizes time-sharing measurement of electric quantity. The power meter divides the 24 hours of a day into several time periods, and then specifies the rate number for each time period. Then the power meter accumulates the amount of electricity in time division according to the pre-divided time period, and stores it to the position of the rate number corresponding to each time period, so as to realize the function of time-division measurement of electricity.

The meter used the method of the tariff number correlation to the starting time point to realize the tariff segment division. The power meter support up to 8 starting time points and up to 4 tariff segments (T1, T2, T3 and T4).

Figure 3-1: The starting time points of the tariff segment

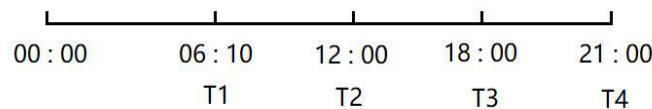

As shown in Figure 3-1, 06:10 designated as the start time of tariff 1 (T1), 12:00 designated as the start time of tariff 2 (T2), 18:00 designated as the start time of tariff 3 (T3), 21:00 designated as the start time of tariff 4 (T4), so tariff 1 time range is 06:10 to 12:00, tariff 2 time range is 12:00 to 18:00, tariff 3 time range is 18:00 to 21:00, tariff 4 time range is 21:00 to tomorrow 06:10.

Note: The tariff parameters can be set by communication commands (Please refer to the relevant communication protocol document for the register address).

3.2. Demand calculation method

The block intervals are sliding, the power meter calculates and update the demand at the sliding speed.

Figure 3-2: Diagram of sliding block interval calculation method

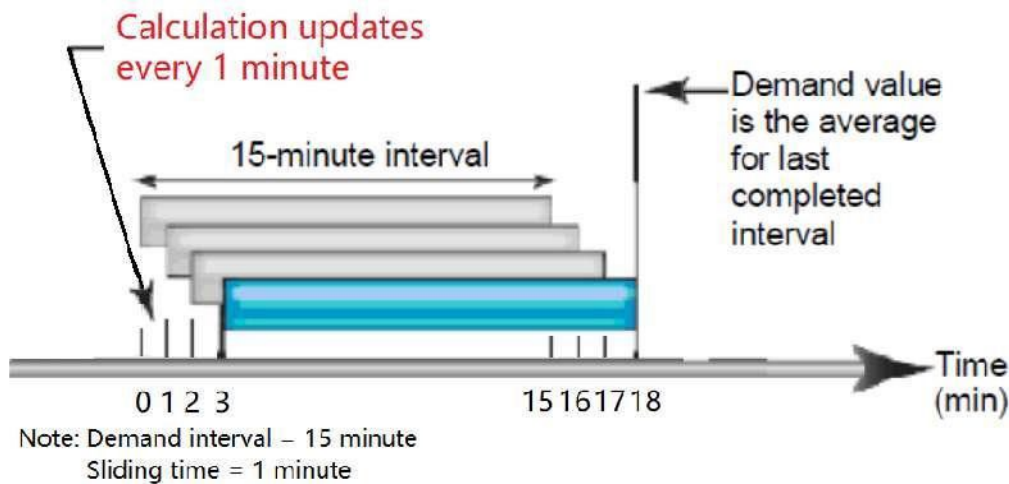

As shown in Figure 3-2, the first demand calculation is made at the 15th minute, and the demand calculation data is between the 0th and the 15th minute. At the 16th minute, do the second demand calculation, and the demand calculation data is between the 1th and the 16th minute. At the 17th minute, do the third demand calculation, and the demand calculation data is between the 2th and the 17th minute.

3.3. Definition of monthly freeze and daily freeze

The **3F-7DIN 7321 WIFI** meter provides the statistical function of monthly and daily electricity consumption. For the time point of monthly freezing and daily freezing, free setting operation can be realized through Tuya APP. The meter can monitor the current time in real time, when the time reaches the set monthly freezing date, the meter will automatically freeze the monthly electricity consumption; when the time reaches the set daily freezing time, the meter will automatically freeze the daily freezing time. The definition of the freezing rule is detailed below:

3.3.1. Monthly freeze rules

The monthly freezing is set by the value of the date. When the time reaches 00:00 of the set date, the meter will freeze the current electricity quantity used and save it as the electricity consumption of the previous month. Ruling definition of month freezing date: the month frozen date is set before 15 days (including 15 days), when the frozen energy is divided into the electricity consumption of the previous month, and the date of the month freezing is set after 15 days, when the month frozen acts, the frozen energy is divided into the electricity consumption of the current month.

Example 1:

The date of monthly freezing is set to 5, assuming the current is 20:00 on July 4, then when the time reaches 00:00 on July 5, the meter will perform the freezing operation of monthly electricity

consumption, dividing the frozen electricity consumption for June (00:00 on June 5 to 00:00 on July 5).

In accordance with the above freezing rules:

Inquiry the July electricity consumption of the meter before 00:00 on July 5 will show 0, because the meter has not reached the monthly freezing date, so the accumulated energy at this time is still the electricity consumption in June.

Example 2:

The date of monthly freeze is set to 27, assuming the current time is 20:00 on July 26, then when the time reaches 00:00 on July 27, the meter will perform the freezing operation of monthly electricity consumption, dividing the frozen electricity consumption for July (00:00 on June 27 to 00:00 July 27).

3.3.2 Daily freeze rules

The daily freezing is set by the value of the time point. When the time reaches the set time point, the meter will freeze the current electricity quantity used and save it as the electricity consumption of the previous day.

Example 1:

The time of daily freezing is set to 3, assuming the current time is 02:00 on July 5, then when the time reaches 03:00 on July 5, the meter will perform the freezing operation of daily electricity consumption, dividing the frozen electricity consumption on July 4 (03:00 on July 4 to 03:00 on July 5).

Example 2:

The time of daily freezing is set to 20, assuming the current time is 02:00 on July 5, then when the time reaches 20:00 on July 5, the meter will perform the freezing operation of daily electricity consumption, dividing the frozen electricity consumption on July 4 (20:00 on July 4 to 20:00 on July 5).

In accordance with the above freezing rules:

If you inquiry the electricity consumption on July 5 at the period between on 20:00 on July 4 to 19:59 on July 5, the meter will show 0. Because the meter has not reached the daily freezing time point, so the accumulated electricity consumption at this time is still the electricity consumption on July 4.

Inquiry the meter electricity consumption on July 5 at the period between on 20:00 July 5 to 19:59 July 6, then the current accumulated electricity consumption value is displayed.

3.3.3 How to setting the month freeze date and day freeze time

Open the Tuya APP, to find the meter to be set up, click to enter the meter interface , click the setting button in the bottom right corner of the screen to enter the setup interface, click "Frozen Set" on the setting interface, select the month freezing date and day freezing time to be set, click the "confirm" button to set up.

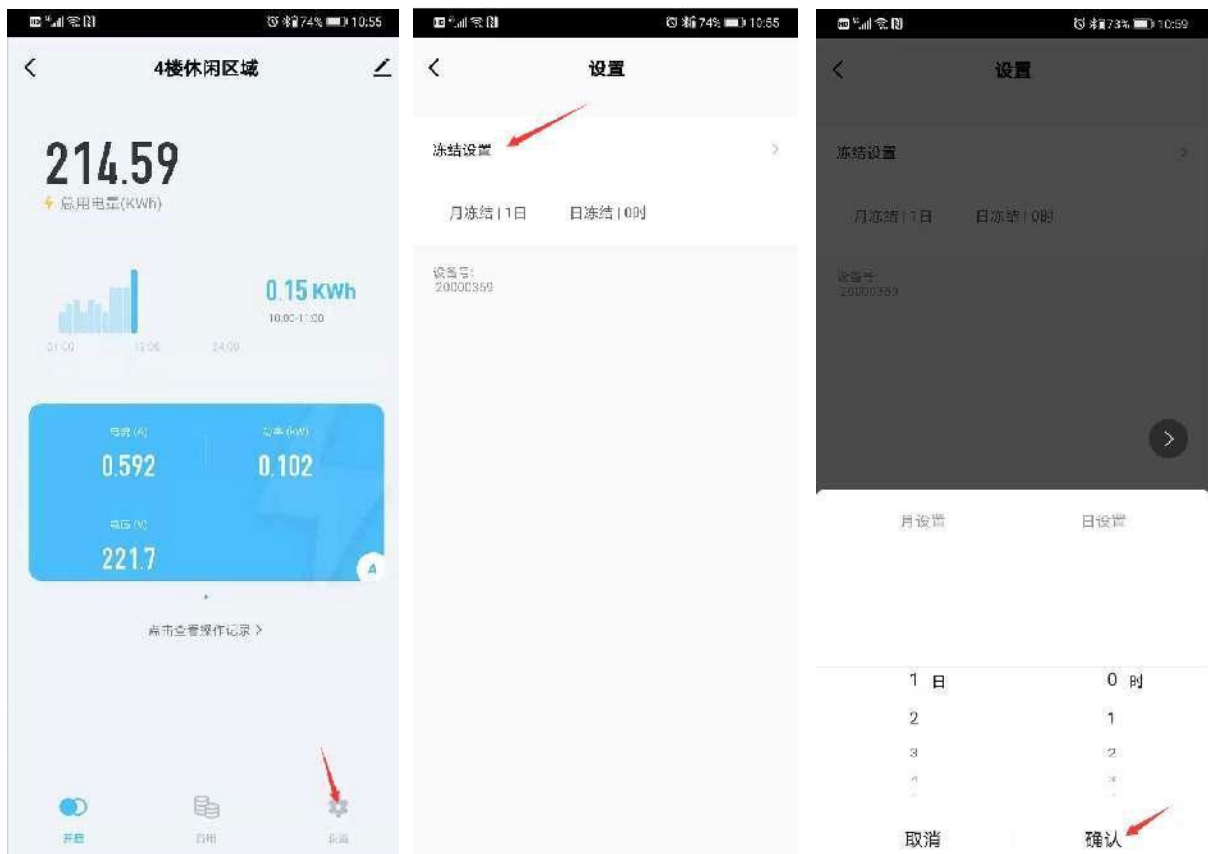

Note:

1. The default month freezing date of the meter is 1th and the day freezing time is 00:00.
2. After reset the freeze date and time, the meter automatically reset data on monthly and daily consumption and then reaccumulates.

Chapter 4. Operation

4.1. Meter startup instructions

After the **3F-7DIN 7321 WIFI** series products are properly wired and connected to the power supply, the products will first enter the self-test process, under which the LCD screen display sequence is shown as follows:

First screen display	Display full screen characters	
Second screen display	Displays the software version number of the power meter	

4.2. LCD display area description

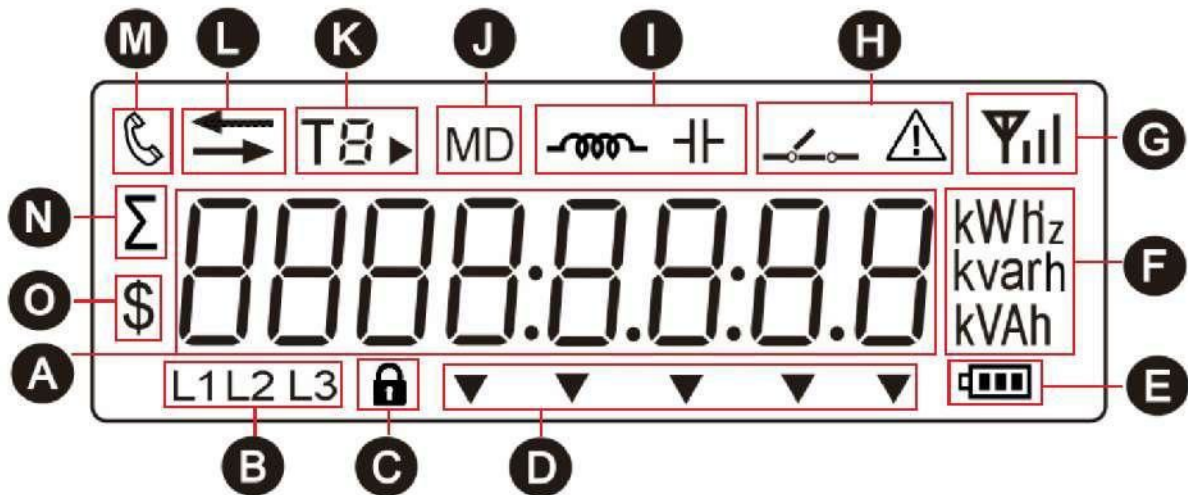

A: Measured values.

B: Phase information icon.

C: Lock icon, dicates that the device is locked.

D: Auxiliary display icon.

E: Battery status Icon displays the battery status.

F: An icon of a unit of measurement data.

G: Wireless signal strength icon.

H: Relay status and warning Status icon.

I: Display icon of the load feature.

J: Maximum demand icon.

K: Multi tariff icon indicating the tariff segment to which the current energy. \blacktriangleright represents the tariff number displayed as the running tariff segment. For example: $T2 \blacktriangleright$ The figure on the left represents that the tariff 2 (T2) segment is running, and the accumulated energy will be counted into the corresponding energy area of tariff 2 (T2).

L: Direction icon for import and export, \longrightarrow mean import, \longleftarrow mean export.

M: Communication Status Icon.

N: Sum icon, which indicates that the data currently displayed is the sum parameter

O: Currency indicator icon.

4.3. Network config operation

Step 1: After completing the wiring according to the wiring diagram of the meter, then power on the meter.

Step 2: Connect the phone's WIFI to the router that the meter needs to connect (make sure 2.4G WIFI, will otherwise cause subsequent config network failure).

Step 3: Open the Tuya smart APP, and click the Add Device button to select "Smart Meter (WIFI)" in the "Energy" category.

Step 4: Verify whether the name and password of the WIFI hotspot prompted on the mobile phone interface belong to the target router needing to be connected. After confirming the information, click the "Next" button to operate according to the prompts to complete the operation of the distribution

network.

Note: During network config, you are advised to enable bluetooth for your mobile phone to improve the smooth network config.

Example:

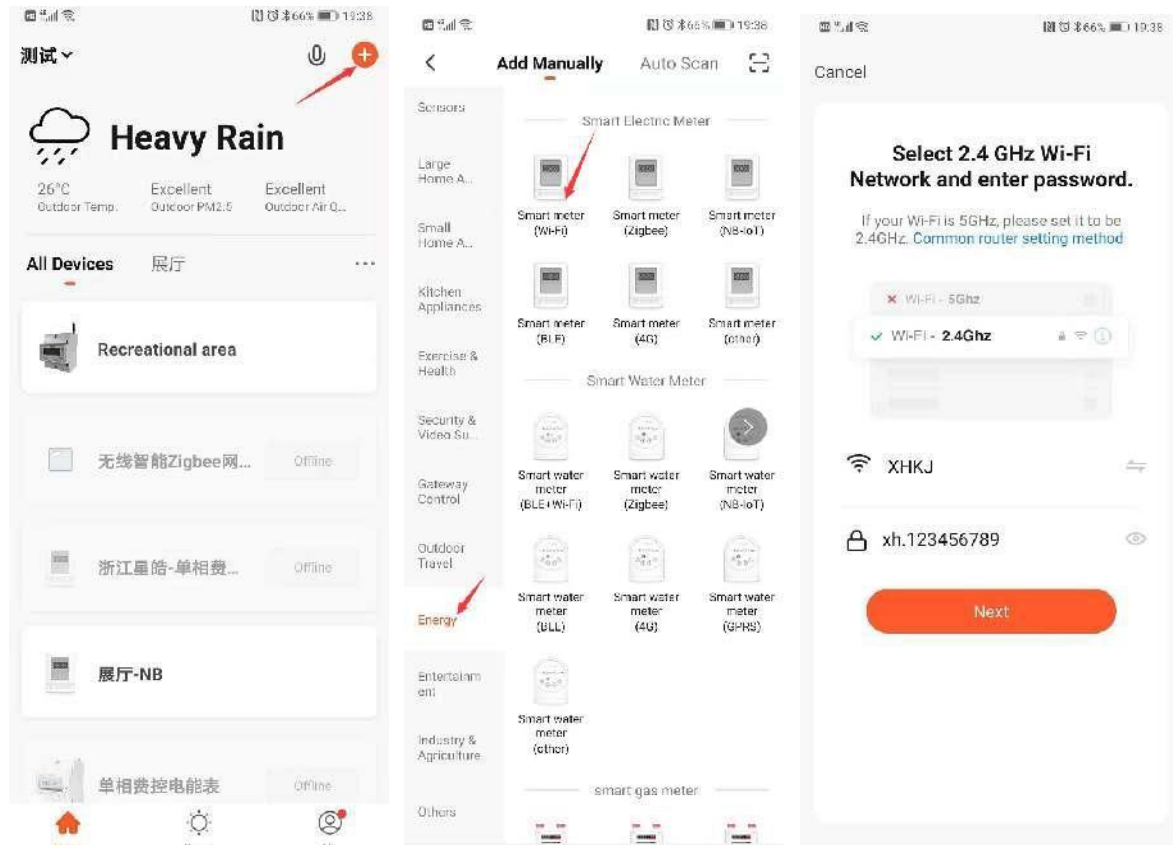









4.4. Button definition description











Button	Definition	Click	Press 3 second
	Button 1: Esc / Scroll	Scroll the page of the displayed page	1. In the main display screen: enter or exit the auxiliary screen. 2. In the setting screen: exit or return to the previous screen.
	Button 2: Confirm / Shift	In the setting screen: right move the setting cursor.	1. In the main display screen: enter the setting mode. 2. In the setting screen: enter the setting state or carry out confirmation operation. 3. In the auxiliary screen: reset WIFI(see 4.4.2 for details)

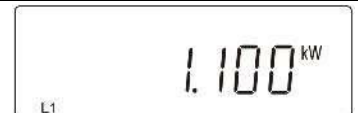
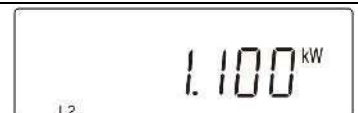
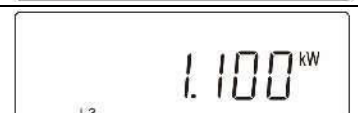
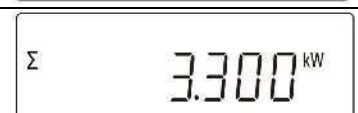



4.5. Description of display screen

4.5.1. Main display screen

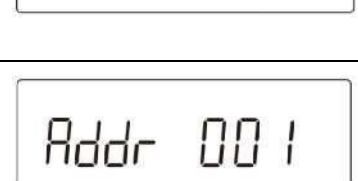
After the meter is powered on and passes the self-test process, the interface entered is defined as the main display interface, which is used to display the main measurement parameters, electric quantity data, instrument information and other data of the product. Users can scroll the display page by pressing the button 1.



LCD display	Description
	Total active energy Example: Total active energy = 335.89kWh
	Tariff 1 active energy Example: Tariff 1 active energy = 100.80kWh Note: Only meter that have the tariff function activated display this screen
	Tariff 2 active energy Example: Tariff 2 active energy = 100.06kWh Note: Only meter that have the tariff function activated display this screen
	Tariff 3 active energy Example: Tariff 3 active energy = 130.00kWh Note: Only meter that have the tariff function activated display this screen
	Tariff 4 active energy Example: Tariff 4 active energy = 5.03kWh Note: Only meter that have the tariff function activated display this screen
	L1-N voltage Example: L1-N voltage = 230.0V
	L2-N voltage Example: L2-N voltage = 230.0V
	L3-N voltage Example: L3-N voltage = 230.0V
	L1 current Example: L1 current = 5.003A

	L2 current Example: L2 current = 5.003A
	L3 current Example: L3 current = 5.003A
	L1 active power Example: L1 active power = 1.100kW
	L2 active power Example: L2 active power = 1.100kW
	L3 active power Example: L3 active power = 1.100kW
	Total active power Example: Total active power = 3.300kW
	L1 power factor Example: L1 power factor = 0.500
	L2 power factor Example: L2 power factor = 0.500
	L3 power factor Example: L3 power factor = 0.500
	Total power factor Example: Total power factor = 0.500
	Frequency Example: Frequency = 50.02Hz
	Displaying the current date of the system real-time clock. Example: The current date is September 26, 200 Note: Only mult-tariff meter show this page
	Displaying the current time of the system real-time clock. Example: The current time is 16:17.08 Note: Only mult-tariff meter show this page
	Modbus address Example: The modbus address is 1.

	Baud rate Example: The baud rate is 9600bps.
	Parity bit Example: The Parity bit is None. Note: The value of E indicates Even, and the value of O indicates odd.
	Pulse output mode and pulse constant of optocoupler output channel. Example: The left figure represents the total active power in the pulse output mode, and the pulse constant is 1000 imp/kWh
	The serial number of meter Example: The serial number is 20111201.
	Software version number

4.5.2. Auxiliary display screen

Under the main display screen, press button 1 for 3 second to enter the screen of auxiliary display. At this point, click button 1 can be scroll the page needs to be viewed. Under the screen of auxiliary display, can press button 1 for 3 second return to the main display screen. If there is no button operation in more than 1 minute under the screen of auxiliary display, the meter will automatically return to the main display screen.

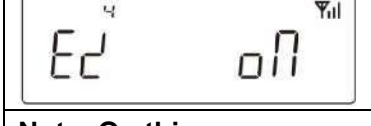
LCD display	Description
1. WIFI status indicator interface	
	Indicates that the current WIFI is in Smartconfig state.
	Indicates that the current WIFI is configured but not connected to the route.
	Indicates that the current WIFI is configured and connected to the router, but not connected to the cloud.
	WIFI connects to a router and connects to the cloud.
Note: On this screen, press button 2 for 3 seconds, WIFI will be reset, and the meter will enter the network configuration mode.	
2. WIFI signal strength indicator interface	

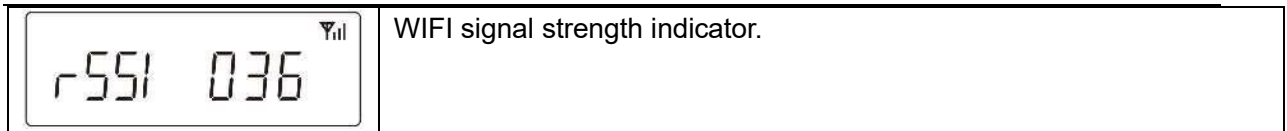

4.6. Setting-up

The logical diagram of the parameter setting menu is as follows:

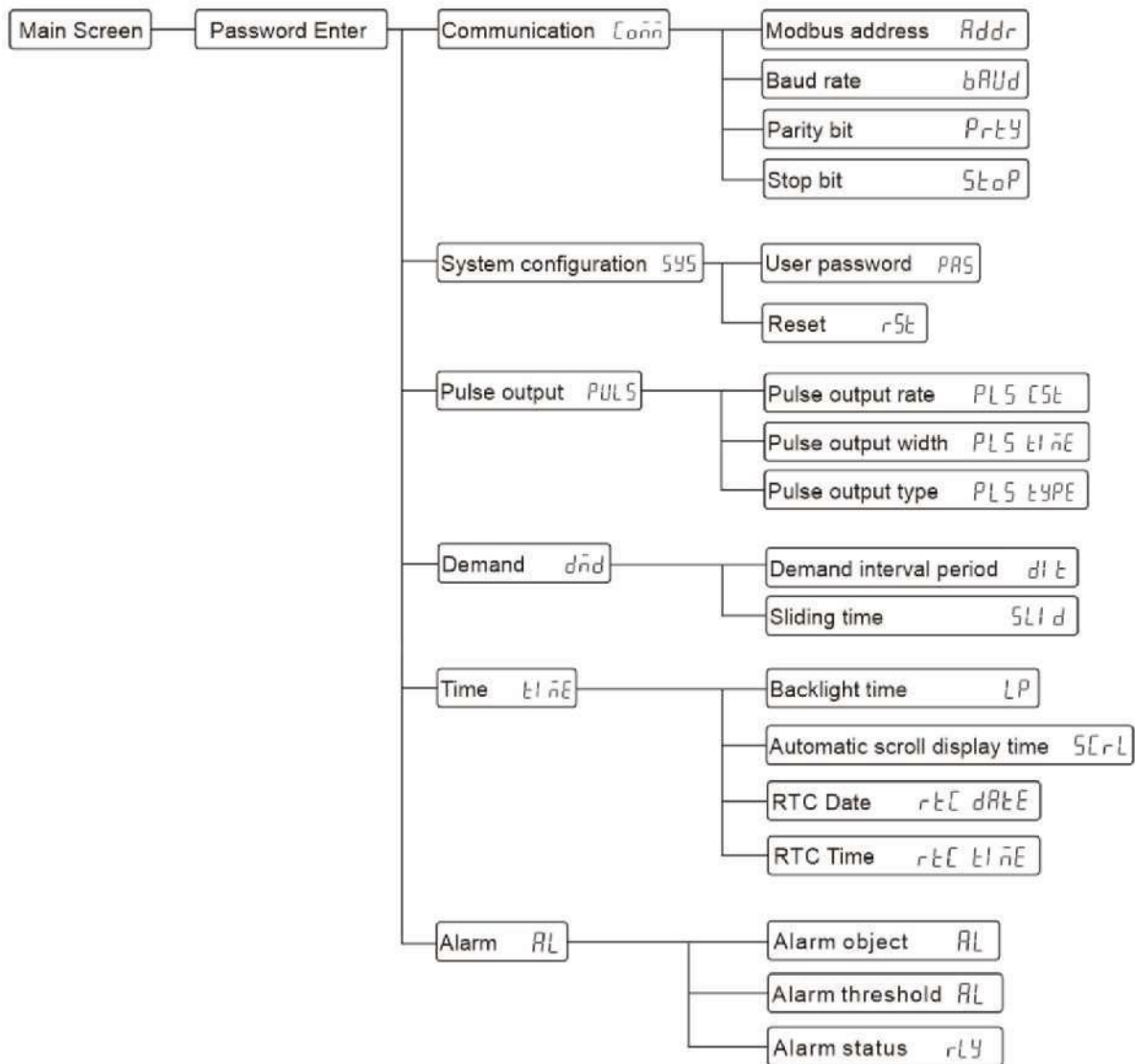

How to enter the "Parameter setting Menu" screen:

Step 1: In the main display screen, press button 2 for 3 second to enter the user password input mode.



Note: The user password input screen is shown in the figure on the right.

Step 2: Enter the correct user password and press button 2 for 3 second to confirm.

How to enter a password:

- A: Click button 1 to increase or decrease the number of flashing bits.
- B: Click button 2 to move the flashing position to the right.
- C: After entering the correct password, press button 2 for 3 second for confirmation. If the password is verified correctly, the power meter will enter the screen of "Parameter Setting menu".

Note: Under the user password input screen, can press 3 second button 1 to return to the main display screen. If there is no button operation in more than 1 minute under this screen, the power meter will automatically return to the main display screen.

4.6.1. Set communication class parameters

Communication parameters include: Modbus address, baud rate, parity bit, stop bit.

1. After entering the "Parameter Setting Menu" screen, select the setting screen (as shown in the figure below), and then press button 2 for 3 second to enter the communication parameter setting screen.

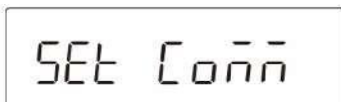





2. Setting the modbus communication address

	<p>Modbus address setting range: 001 to 247, default is 001.</p> <p>Press button 2 for 3 second to enter the setting state, and the digit of the setting becomes the flashing state.</p> <p>Click button 1 to scroll the page and select the next setting interface.</p> <p>Press button 1 for 3 second to exit the setting menu and return to the previous setting screen.</p>
--	---

	<p>Click button 1 to increase or decrease the number of set bits.</p> <p>Click button 2 can be moved the set bits to the right.</p> <p>Press button 2 for 3 second to confirm the setting. The meter will save the setting value and exit the setting state.</p> <p>Press button 1 for 3 second to exit the setting state without saving the setting parameters.</p>
--	--

3. Setting the baud rate

	<p>Baud rate can be setting: 1200, 2400, 4800, 9600 bps, default is 9600bps.</p> <p>Press button 2 for 3 second to enter the setting state, and the digit of the setting becomes the flashing state.</p> <p>Click button 1 to scroll the page and select the next setting interface.</p> <p>Press button 1 for 3 second to exit the setting menu and return to the previous setting screen.</p>
--	---





	<p>Click button 1 to select the baud rate.</p> <p>Press button 2 for 3 second to confirm the setting. The meter will save the setting value and exit the setting state.</p> <p>Press button 1 for 3 second to exit the setting state without saving the setting parameters.</p>
4. Setting the parity bit	
	<p>Parity bit can be setting: None, Even, Odd, default is None.</p> <p>Press button 2 for 3 second to enter the setting state, and the character of the setting becomes the flashing state.</p> <p>Click button 1 to scroll the page and select the next setting interface.</p> <p>Press button 1 for 3 second to exit the setting menu and return to the previous setting screen.</p>
	<p>Click button 1 to select the parity bit.</p> <p>Press button 2 for 3 second to confirm the setting. The meter will save the setting value and exit the setting state.</p> <p>Press button 1 for 3 second to exit the setting state without saving the setting parameters.</p> <p>Note: N is mean None, E is mean Even, O is mean Odd.</p>
5. Setting the stop bit	
	<p>Stop bit can be setting: 1 or 2, default is 1.</p> <p>Press button 2 for 3 second to enter the setting state, and the digit of the setting becomes the flashing state.</p> <p>Click button 1 to scroll the page and select the next setting interface.</p> <p>Press button 1 for 3 second to exit the setting menu and return to the previous setting screen.</p> <p>Note: The stop bit can only be set to 2 if the check bit is equal to None.</p>
	<p>Click button 1 to select the stop bit.</p> <p>Press button 2 for 3 second to confirm the setting. The meter will save the setting value and exit the setting state.</p> <p>Press button 1 for 3 second to exit the setting state without saving the setting parameters.</p>

4.6.2. Set system class parameters

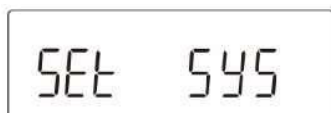
System class parameters include: user password, reset max. demand.

1. After entering the "Parameter Setting Menu" screen, select the setting screen (as shown in the figure below), and then press button 2 for 3 second to enter the system class parameter setting screen.

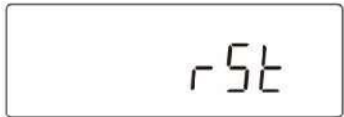







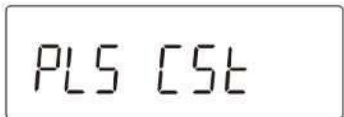



2. Setting user password	
	<p>User password setting range:0000 to 9999, default is 0000.</p> <p>Press button 2 for 3 second to enter the setting state, and the digit of the setting becomes the flashing state.</p> <p>Click button 1 to scroll the page and select the next setting interface.</p> <p>Press button 1 for 3 second to exit the setting menu and return to the previous setting screen.</p>
	<p>Click button 1 to increase or decrease the number of set bits.</p> <p>Click button 2 can be moved the set bits to the right.</p> <p>Press button 2 for 3 second to confirm the setting. The meter will save the setting value and exit the setting state.</p> <p>Press button 1 for 3 second to exit the setting state without saving the setting parameters.</p>
3. Reset Max. demand	
	<p>Press button 2 for 3 second to enter the reset state.</p> <p>Click button 1 to scroll the page and select the next setting interface.</p> <p>Press button 1 for 3 second to exit the setting menu and return to the previous setting screen.</p>
	<p>Press button 2 for 3 second to confirm the reset. The meter will reset the selected option and exit the reset state.</p> <p>Press button 1 for 3 second to exit the reset state without reset the selected option.</p>

4.6.3. Set pulse output class parameters

Pulse output class parameters include: pulse output type, pulse output rate and pulse output width.

1. After entering the "Parameter Setting Menu" screen, select the setting screen (as shown in the figure below), and then press button 2 for 3 second to enter the pulse output class parameter setting screen.	
	
2. Setting pulse constant	
	<p>Pulse constant can be set: 1, 10, 100, 1000 imp/kWh(kvarh), default is 1000 imp/kWh(kvarh).</p> <p>Press button 2 for 3 second to enter the setting state, and the digit of the setting becomes the flashing state.</p> <p>Click button 1 to scroll the page and select the next setting interface.</p> <p>Press button 1 for 3 second to return to the previous level setup menu.</p> <p>Note: The pulse constant cannot be set to 1000 when the pulse width time is equal to 200ms.</p>

	<p>Click button 1 to select the pulse constant.</p> <p>Press button 2 for 3 second to confirm the setting. The power meter will save the setting value and exit the setting state.</p> <p>Press button 1 for 3 second to exit the setting state without saving the setting parameters.</p>
3. Setting pulse output width	
	<p>The pulse output width represents the effective duration of the pulse output.</p> <p>Options that can be set: 60, 100, 200, unit is ms, default is 100ms.</p> <p>Press button 2 for 3 second to enter the setting state, and the digit of the setting becomes the flashing state.</p> <p>Click button 1 to scroll the page and select the next setting interface.</p> <p>Press button 1 for 3 second to return to the previous level setup menu.</p> <p>Note: When the pulse constant is equal to 1000 imp/kWh(kvarh), the pulse width time cannot be set to 200ms.</p>
	<p>Click button 1 to select the pulse output width.</p> <p>Press button 2 for 3 second to confirm the setting. The power meter will save the setting value and exit the setting state.</p> <p>Press button 1 for 3 second to exit the setting state without saving the setting parameters.</p>
4. Setting pulse output type	
	<p>The type of energy represented by the pulse output.</p> <p>Options that can be set: total active energy, import active energy, export active energy, total reactive energy, import reactive energy, export reactive energy, default is total active energy.</p> <p>Press button 2 for 3 second to enter the setting state, and the character of the setting becomes the flashing state.</p> <p>Click button 1 to scroll the page and select the next setting interface.</p> <p>Press button 1 for 3 second to return to the previous level setup menu.</p>
	<p>Click button 1 to select the pulse output type.</p> <p>Press button 2 for 3 second to confirm the setting. The meter will save the setting value and exit the setting state.</p> <p>Press button 1 for 3 second to exit the setting state without saving the setting parameters.</p>
Note: Pulse output type corresponding to the display characte	
	<p>On the left, the pulse output type is total active power</p>

	On the left, the pulse output type is import active power
	On the left, the pulse output type is export active power
	On the left, the pulse output type is total reactive power
	On the left, the pulse output type is import reactive power
	On the left, the pulse output type is export reactive power

4.6.4. Set demand class parameters

Demand class parameters include: demand interval period and sliding time.

1. After entering the "Parameter Setting Menu" screen, select the setting screen (as shown in the figure below), and then press button 2 for 3 second to enter the demand class parameter setting screen.

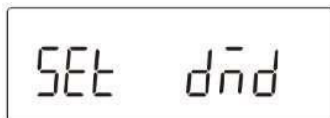

2. Setting demand interval period



Demand interval period can be set: 0 to 60, unit is minute, default is 60 minutes.

Press button 2 for 3 second to enter the setting state, and the digit of the setting becomes the flashing state.

Click button 1 to scroll the page and select the next setting interface. Press button 1 for 3 second to return to the previous level setup menu.

Note: If the demand interval period is set to 0 minutes, then the demand is updated every second.





Click button 1 to increase or decrease the number of set bits.

Click button 2 can be moved the set bits to the right.



Press button 2 for 3 second to confirm the setting. The meter will save the setting value and exit the setting state.





Press button 1 for 3 second to exit the setting state without saving

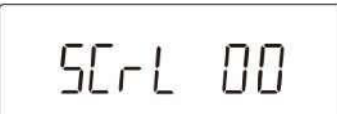

	the setting parameters.
3. Setting sliding time	
	<p>Sliding time setting range: 1 to (demand interval period), unit is minutes, default is 1 minute.</p> <p>Press button 2 for 3 second to enter the setting state, and the digit of the setting becomes the flashing state.</p> <p>Click button 1 to scroll the page and select the next setting interface.</p> <p>Press button 1 for 3 second to return to the previous level setup menu.</p> <p>Note: The slip time has no effect when the demand interval period is set to 0.</p>
	<p>Click button 1 to increase or decrease the number of set bits.</p> <p>Click button 2 can be moved the set bits to the right.</p> <p>Press button 2 for 3 second to confirm the setting. The meter will save the setting value and exit the setting state.</p> <p>Press button 1 for 3 second to exit the setting state without saving the setting parameters.</p>

4.6.5. Set time class parameters

Time class parameters include: backlight time, automatic scroll display time, System time (RTC) and Tariff time.

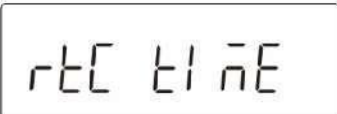
<p>1. After entering the "Parameter Setting Menu" screen, select the setting screen (as shown in the figure below), and then press button 2 for 3 second to enter the time class parameter setting screen.</p> 	
2. Setting backlight time	
	<p>Backlight time can be set: on, off, 5, 10, 30, 60, 120, unit is minute, default is 60 minutes.</p> <p>Press button 2 for 3 second to enter the setting state, and the character of the setting becomes the flashing state.</p> <p>Click button 1 to scroll the page and select the next setting interface.</p> <p>Press button 1 for 3 second to return to the previous level setup menu.</p> <p>Note:</p> <ol style="list-style-type: none"> 1. The character "on" means the backlight is always on, and "off" means the backlight is always off. 2. If you need to setting other values within 120 minutes, use the communication command to do so.

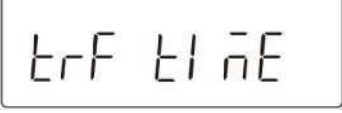
	<p>Click button 1 to select the backlight time.</p> <p>Press button 2 for 3 second to confirm the setting. The power meter will save the setting value and exit the setting state.</p> <p>Press button 1 for 3 second to exit the setting state without saving the setting parameters.</p> <p>Note: <i>on</i> That means is on. <i>off</i> That means is off.</p>
3. Setting automatic scroll display time	
	<p>Automatic scroll display time set range: 0 to 60, unit is second, default is 0 second.</p> <p>Press button 2 for 3 second to enter the setting state, and the digit of the setting becomes the flashing state.</p> <p>Click button 1 to scroll the page and select the next setting interface.</p> <p>Press button 1 for 3 second to return to the previous level setup menu.</p> <p>Note: Automatic scroll display time is 0, means no automatic wheel display</p>
	<p>Click button 1 to increase or decrease the number of set bits.</p> <p>Click button 2 can be moved the set bits to the right.</p> <p>Press button 2 for 3 second to confirm the setting. The power meter will save the setting value and exit the setting state.</p> <p>Press button 1 for 3 second to exit the setting state without saving the setting parameters.</p>
4. Setting date of RTC (Only multitariff meter support this menu)	
	<p>Press button 2 for 3 second to enter the setting state, and the digit of the setting becomes the flashing state.</p> <p>Click button 1 to scroll the page and select the next setting interface.</p> <p>Press button 1 for 3 second to return to the previous level setup menu.</p>
	<p>Click button 1 to increase or decrease the number of set bits.</p> <p>Click button 2 can be moved the set bits to the right.</p> <p>Press button 2 for 3 second to confirm the setting. The meter will save the setting value and exit the setting state.</p> <p>Press button 1 for 3 second to exit the setting state without saving the setting parameters.</p>
5. Setting system time (RTC) (Only multitariff meter support this menu)	
	<p>Press button 2 for 3 second to enter the setting state, and the digit of the setting becomes the flashing state.</p> <p>Click button 1 to scroll the page and select the next setting interface.</p> <p>Press button 1 for 3 second to return to the previous level setup menu.</p>

	<p>Click button 1 to increase or decrease the number of set bits. Click button 2 can be moved the set bits to the right. Press button 2 for 3 second to confirm the setting. The meter will save the setting value and exit the setting state. Press button 1 for 3 second to exit the setting state without saving the setting parameters.</p>
6. View tariff time (Only mult-tariff meter support this menu)	
	<p>View menu for tariff information.</p> <p>Press button 2 for 3 second to enter the screen for veiw tariff information. Click button 1 to scroll the page and select the next setting screen. Press button 1 for 3 second to return to the previous level setup menu.</p> <p>Note: The menu cannot be setting and can only be viewed.</p>
	<p>The screen for displaying the tariff information.</p> <ol style="list-style-type: none"> 1. The number displayed on the left side of the screen represents the sequence number of the selected starting time point. The meter supports 8 starting time points and 4 tariff segments. 2. The character displayed on the right side of the screen represents the starting time of the tariff segment (format is hours: minutes). 3. T2 in the upper left corner of the screen indicates that the current tariff is T2. The meter supports 4 tariff segments. (T1 to T4) <p>Click button 1 scroll the page and select the next screen. Press button 1 for 3 second to exit the setting state without saving the setting parameters.</p> <p>Note: If T0 is displayed, the time segment is invalid and does not belong to any tariff.</p>

4.6.6. View alarm parameters

The alarm parameters include: alarm object, alarm threshold value, current alarm status.

<p>1. After entering the "Parameter Setting Menu" screen, select the setting screen (as shown in the figure below), and then press button 2 for 3 second to enter the alarm parameter viewing screen.</p> 
<p>2. View alarm object (Only view)</p>

	<p>The left figure represents the alarm monitor object is L2-N voltage.</p> <p>Click button 1 to scroll the page and select the next view screen. Press button 1 for 3 second to return to the previous level setup menu.</p>
---	---

The corresponding character table of the alarm object

Display	Alarm object	Display	Alarm object	Display	Alarm object
U1	L1-N voltage	I A ¹	Average current	S2	L2 apparent power
U2	L2-N voltage	I N	Neutral current	S3	L3 apparent power
U3	L3-N voltage	P1	L1 active power	S	Total apparent power
U ^A 1	Average voltage of L-N	P2	L2 active power	F	Frequency
U12	L1-2 voltage	P3	L3 active power	U ^N PH	Per phase L-N voltage
U23	L2-3 voltage	P	Total active power	U ^U PH	Per phase L-L voltage
U31	L3-1 voltage	Q1	L1 reactive power	I-PH	Per phase current
U ^A A ¹	Average voltage of L-L	Q2	L2 reactive power	P-PH	Per phase active power
I1	L1 current	Q3	L3 reactive power	Q-PH	Per phase reactive power
I2	L2 current	Q	Total reactive power	S-PH	Per phase apparent power
I3	L3 current	S1	L1 apparent power	NULL	is mean no alarm object is associated, that is, the alarm function is disabled.

Note: If the alarm parameter set by the meter is per phase parameter, the meter will trigger the alarm action (disconnect the relay) as long as any phase parameter of the three-phase parameter is detected to exceed the set alarm threshold.

3. View alarm threshold value (Only view)

	<p>The left figure represents that the current alarm threshold is 220.0V. When the meter detects that the voltage exceeds the threshold, it will disconnect the relay and give relevant alarm.</p> <p>Click button 1 to scroll the page and select the next view screen. Press button 1 for 3 second to return to the previous level setup menu.</p>
---	--

4. View alarm status (Only view)

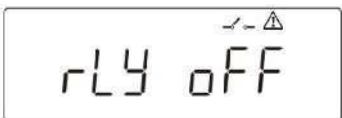
	<p>The left figure indicates that the alarm has been triggered and the relay is disconnected.</p> <p>Click button 1 to scroll the page and select the next view screen. Press button 1 for 3 second to return to the previous level setup menu.</p> <p>Note: 1. When the alarm occurs, the relay will automatically disconnect.</p>
---	---

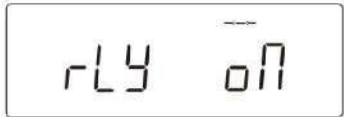
	After the alarm fault is removed, the relay needs to be closed manually. 2. In this screen, press button 2 for 3 second to enter confirm status, and then press button 2 for 3 second again to manually close the relay.
	The left figure indicates that no alarm is triggered and the relay is in the connect state.

Chapter 5. Alarm

3F-7DIN 7321 WIFI series products can support the alarm function, which is associated with the inbuilt-relay of the meter. According to the real-time measurement data of the monitored object and the set alarm threshold, if the measured data exceeds the set threshold value, the instrument will automatically disconnect the relay and perform alarm prompt. The alarm function is to compare the measured data of the monitored object with the alarm threshold value every second, to judge whether the alarm threshold value is exceeded, and if it is, the alarm action will be triggered

5.1. Alarm parameter description

1. Alarm monitoring object: the measurement parameters associated with the alarm. The meter compares the data of the measurement parameters every second to determine whether the alarm threshold is exceeded, so as to decide whether to trigger the alarm. The alarm monitoring object supports six measurement parameters. The specific alarm object is shown in Table 7-1 below.

2. Alarm action delay time: When an alarm event occurs, the alarm action will be performed only after the delay time. If the delay time is set to 0, the alarm action will be executed immediately.

3. Alarm threshold: When the measured data of the monitored object is greater than this threshold, an alarm event will be triggered.

Table 7-1: Alarm monitoring object

No.	Alarm parameter	No.	Alarm parameter	No.	Alarm parameter
0	L1-N voltage	11	Average current	22	L2 apparent power
1	L2-N voltage	12	Neutral current	23	L3 apparent power
2	L3-N voltage	13	L1 active power	24	Total apparent power
3	Average voltage of L-N	14	L2 active power	25	Frequency
4	L1-2 voltage	15	L3 active power	26	Per phase L-N voltage
5	L2-3 voltage	16	Total active power	27	Per phase L-L voltage
6	L3-1 voltage	17	L1 reactive power	28	Per phase current
7	Average voltage of L-L	18	L2 reactive power	29	Per phase active power
8	L1 current	19	L3 reactive power	30	Per phase reactive power
9	L2 current	20	Total reactive power	31	Per phase apparent power
10	L3 current	21	L1 apparent power		

5.2. Alarm parameter setting process

Step1: Binding the alarm monitoring object.

Step2: Setting the alarm action delay time.

Step3: Setting alarm threshold value.

Note:

- 1, alarm parameters support communication command setting, the setting menu only provides the function of viewing.
2. Before resetting the alarm monitoring object each time, it is necessary to pay attention to the value of the threshold value to prevent the alarm from being triggered by mistake.

5.3. Alarm action process

After the alarm monitoring object is associated, the meter compares the measured data and alarm threshold value of the monitored object every second, if the measured data is greater than the alarm threshold value, the alarm event will be triggered. At this time, the meter will judge whether the "alarm action delay time" is equal to 0. If it is equal to 0, the following alarm action will be executed immediately; if it is not equal to 0, the following alarm action will be performed first.

Alarm action of meter:

1. Disconnect the meter inbuilt-relay.
2. The LCD will display the alarm icon: 
3. Light the relay indicator light of the meter.
4. Generates an SOE event and records it to memory.

Note:

1. When the instrument alarms, in order to prevent the closure of the relay before the fault is removed, it is necessary to manually close the relay after troubleshooting the fault. The operation mode of manually closed relay supports key operation and remote communication operation.
2. SOE event information can be read by RS485 communication.

Appendix



Appendix A – LCD character definition table

0	1	2	3	4	5	6	7	8	9
0	1	2	3	4	5	6	7	8	9
A	b	C	d	E	F	G	H	I	J
A	B	C	D	E	F	G	H	I	J
K	L	M	N	O	P	Q	R	S	T
K	L	M	N	O	P	Q	R	S	T
U	V	W	X	Y	Z				
U	V	W	X	Y	Z				

Appendix B – Failure code reference table

No.	Fault code	Fault description
1	Err-01	Relay cannot be disconnected fault
2	Err-08	The battery voltage is too low.
3	Err-09	1. Relay cannot be disconnected fault 2. The battery voltage is too low
4	Err-16	WIFI module fault
5	Err-17	1. Relay cannot be disconnected fault 2. WIFI module fault
6	Err-24	1. The battery voltage is too low 2. WIFI module fault
7	Err-25	1. Relay cannot be disconnected fault 2. The battery voltage is too low 3. WIFI module fault

Appendix C – Alarm prompt comparison table

No.	The action of the meter	Alarm definition
1	LCD display alarm icon  , but no fault code	The overlimit alarm of the monitored object occurs
2	LCD does not display alarm icon  , but it does display fault code	Meter fault

Appendix D – WIFI indicator status table

No.	WIFI LED flashing status	Description
1	Fast flashing	Indicates that the current WIFI is in Smartconfig state.
2	Slow flashing	Indicates that the current WIFI is in AP-config state.
3	On for 0.25 seconds and off for 2 seconds	Indicates that the current WIFI is configured but not connected to the route.
4	On for 0.25 seconds and off for 1 seconds	Indicates that the current WIFI is configured and connected to the router, but not connected to the cloud.
5	On	WIFI connects to a router and connects to the cloud.